

Marine Mammal Behavioral Response Studies in Southern California: Advances in Technology and Experimental Methods

AUTHORS

Brandon L. Southall

Southall Environmental Associates, Inc., Aptos, California

Long Marine Laboratory, University of California, Santa Cruz

Duke University Marine Laboratory

David Moretti

Naval Undersea Warfare Center, Newport, Rhode Island

Bruce Abraham

Applied Physical Sciences Corporation, Groton, Connecticut

John Calambokidis

Cascadia Research Collective, Olympia, Washington

Stacy L. DeRuiter

Centre for Research into Ecological and Environmental Modeling, University of St. Andrews

Peter L. Tyack

Sea Mammal Research Unit, Scottish Oceans Institute, University of St. Andrews

Introduction

How noise from human activities affects marine life has been an area of increasing investigation and associated technology development (see NRC, 2003, 2005; Southall et al., 2007, 2009). Advanced passive listening capabilities have been used to quantify acute impacts of human sounds (e.g., Clark et al., 2009;

ABSTRACT

Behavioral response studies (BRS) are increasingly being conducted to better understand basic behavioral patterns in marine animals and how underwater sounds, including from human sources, can affect them. These studies are being enabled and enhanced by advances in both acoustic sensing and transmission technologies. In the design of a 5-year project in southern California ("SOCAL-BRS"), the development of a compact, hand-deployable, ship-powered, 15-element vertical line array sound source enabled a fundamental change in overall project configuration from earlier efforts. The reduced size and power requirements of the sound source, which achieved relatively high output levels and directivity characteristics specified in the experimental design, enabled the use of substantially smaller research vessels. This size reduction favored a decentralization of field effort, with greater emphasis on mobile small boat operations capable of covering large areas to locate and tag marine mammals. These changes in configuration directly contributed to significant increases in tagging focal animals and conducting sound exposure experiments. During field experiments, received sound levels on tagged animals of several different species were within specified target ranges, demonstrating the efficacy of these new solutions to challenging field research problems. Keywords: marine mammals, noise, underwater sound, transducer, behavioral response study

McCarthy et al., 2011) and monitor acoustic habitats (see Van Parijs et al., 2009). The development of sophisticated tags deployed on animals that record movement and received sounds (see Johnson et al., 2009) has significantly advanced the ability to measure behavior in marine mammals.

There are increasing concerns regarding chronic noise and marine life (e.g., Clark et al., 2009), but much of the public and regulatory interest in the effects of noise on marine life derived from marine mammal stranding events coincident with military active sonar exercises (e.g., Frantzis, 1998; Balcomb & Claridge, 2001;

Fernández et al., 2005). These events demonstrated that in certain conditions, some sounds can harm or mortally injure marine mammals. As reviewed by Cox et al. (2006) and D'Amico et al. (2009), there are some similarities among these events. All involved midfrequency active (MFA) military sonar (and in some cases, other active sources) used in deep water fairly near shore. Additionally, injured or dead individuals were predominately from a few beaked whale species, and they mass-stranded within hours of nearby naval active sonar exercises. Despite these similarities and fairly intensive investigation of

damage to stranded marine mammals (e.g., Fernández et al., 2005), the underlying direct physical and/or behavioral mechanisms for the injuries and mortalities observed remain unknown.

The need for directed behavioral response studies (BRS) of marine mammal responses to human sounds, including midfrequency sonar signals, has thus been widely recommended by various scientific and government bodies (e.g., NRC, 2003; Cox et al., 2006; Southall et al., 2007, 2009; Boyd et al., 2008). The basic methods for conducting controlled exposure experiments (CEEs) to measure behavioral responses have been developed in studies on terrestrial animals and applied to the marine environment (see Tyack, 2009).

Recent studies have used these methods in studying responses to simulated military sonar. In 2007–2008, a BRS testing the responses of tagged marine mammals to simulated MFA sonar was conducted at the U.S. Navy's Atlantic Undersea Test and Evaluation Center (AUTECH) in the Bahamas. The responses of Blainville's beaked whales (*Mesoplodon densirostris*), one of the species involved in previous stranding events following actual military sonar exercises, included clear changes in vocal and diving behavior and sustained avoidance following exposure to simulated sonar, predator sounds, and pseudorandom noise (Tyack et al., 2011); these experimental results were consistent with opportunistic observations of animals in response to realistic military exercises in the same study. This was the first measurement of individual beaked whales of any species exposed to known levels of MFA sonar in a CEE; the results are thus extremely important. However, given the relative cost and effort, the total number of

CEEs conducted was quite small. This was due to constraints including few suitable weather days; relatively low animal density, especially beaked whales at AUTECH with ~25 animals/1,000 km (Moretti et al., 2006; Marques et al., 2009); and the difficulty associated with attaching tags to beaked whales. A follow-on research effort in the western Mediterranean Sea in 2009, while managing to survey numerous poorly known areas and achieve several significant technological advances, also had limited success in tagging and conducting CEEs (D'Amico et al., 2010).

A related project, in terms of objectives and some aspects of methodology, is the "3S" research collaboration among academic scientists and Dutch and Norwegian Navies. The first phase of this project (2006–2009) studied the behavioral effects of naval sonar on killer whales (*Orcinus orca*), sperm whales (*Physeter macrocephalus*), and long-finned pilot whales (*Globicephala melas*) in Norwegian waters; a second phase is ongoing, focusing on additional marine mammal species. This project is generally similar to the Bahamas BRS projects in terms of the overall team configuration and experimental methodology, in that it uses acoustic tags to measure responses of animals to controlled sonar and other signals. However, 3S has a broader species focus to provide more operational flexibility based on optimal animal and weather conditions. Additionally, a realistic towed sound source was used, which allowed aspects of relative movement to be manipulated in order to mimic aspects of sonar interactions with marine mammals. The first phase of the 3S project managed a higher success rate of tagging and CEEs with received sound levels in the specified target range than in the

Bahamas BRS (for 190 more details, see the 3S phase I final 191 report at <http://soi.st-andrews.ac.uk/192/documents/424.pdf>), although on a variety of species generally easier to tag than beaked whales.

The Bahamas and Mediterranean Sea BRS efforts involved large (~100 m) oceanographic research vessels, large research teams, somewhat limited mobility and independence of small vessel operations, and the regimented test plans typical of complex field projects. Some of these characteristics (e.g., the need for interdisciplinary expertise within the research team) are unavoidable given the complexity of acoustical and biological methods and measurements. However, other features resulted from the initial study design. For instance, as in many previous oceanographic acoustic studies involving relatively loud acoustic transmissions, quite large underwater sound sources were used to produce the required sound levels. These sources weighed hundreds of kilograms and required a room full of amplifiers and cooling equipment. This in turn necessitated the use of a large support vessel with ample deck space and an A-frame for deployment. The consequent use of large, oceanographic research vessels resulted in relatively high cost and a general inflexibility in operational times and areas. With this configuration of a large research platform to support large teams and sound source requirements, operations were highly centralized, with visual detection and monitoring teams predominately based on or near this large, slower vessel. The height and stability of the observation platform on these ships has clear advantages for visually surveying large areas. However, it favored the use of small boats that could be kept aboard the larger vessels and deployed

in ideal conditions to follow and tag nearby animals. Their restricted ability to search large areas and be immediately ready to capitalize on any available opportunities to deploy tags was a key limiting factor the number of CEEs completed.

These earlier studies achieved important accomplishments and provided valuable data to inform management decisions and operational planning for the Navy (e.g., Tyack et al., 2011), despite the limited sample size. In evolving the Bahamas BRS efforts, researchers and program managers debated options for modifying study methodologies and technologies to enable testing more individuals and species in a more efficient and economical manner.

In 2010, the U.S. Navy began supporting a multiyear interdisciplinary behavioral research effort in southern California ("SOCAL BRS"). The intent was to build on the accomplishments of earlier studies while deriving a more agile, cost-effective study that increased the number of species and individuals tested. An experimental design similar to previous research efforts was used, involving a scaled sound source projecting simulated military sonar signals and acoustic/movement tags on animals to measure calibrated received sound levels and behavioral responses. Utilizing this design, the overall approach in the first year of this study (SOCAL-10) was to: (1) concentrate efforts in an area of relatively higher marine mammal density and species diversity to enable flexibility in species selection based on conditions; (2) emphasize flexibility by streamlining the size, complexity, and rigid scheduling of previous operational plans, with the development of a smaller sound source being a key enabler; and (3) decentralize the nature of the

research team with an emphasis on mobility and capability of small boat operations. This paper focuses on the modifications in experimental design and sound source technology used in SOCAL-10 and refinements based on lessons-learned in SOCAL-11.

Experimental Methods

The primary objective in modifying configurations from earlier studies was increasing efficiency and operational mobility for rapid response to areas of favorable weather and available subjects. A significant challenge was in reducing the size of the primary research vessel for conducting CEEs. A driving factor in the previous use of large vessels was the requirement for large underwater sound projectors to generate sufficiently loud signals. While using source levels well below those of actual military midfrequency sonar systems (~ 235 dB RMS [root mean square] re: $1 \mu\text{Pa}$ [hereafter dB] at 1 m), this and previous studies projected midfrequency (3–4 kHz fundamental frequency) sonar signals that simulate military systems in certain regards (stimulus waveform, duration, and duty cycle) at source output levels of up to ~ 210 dB.

The ability to project simulated midfrequency sonar signals at such levels from a system that was hand-deployed, powered, and operated from a much smaller research vessel was a significant technical challenge. To streamline the SOCAL-BRS in relation to previous projects, engineers working in collaboration with biologists undertook the design of such a system. Achieving this objective proved critical in modifying the experimental design to enable a more flexible research configuration with CEEs on a relatively large number of species and individuals.

Sound Source Development and Testing

The CEE protocols called for projecting relatively short (~ 1.5 s) simulated midfrequency sonar sounds and pseudorandom noise signals with predominant energy in the 3–4 kHz band once every 25 s for up to 30 min. The target for received sound levels on focal animals during CEEs was ~ 100 – 160 dB. Accounting for propagation losses from a source ~ 1 km from the animals (the notional range during transmissions), this meant that source levels for these midfrequency sounds had to be capable of generating ~ 160 to ~ 210 dB at 1 m. The nontrivial engineering objective was to develop, calibrate, and operate a sound source that could achieve these output specifications in an overall package that could be housed, powered, rapidly hand-deployed (< 5 min) to 30-m depth, and recovered from a medium-sized (15–30 m) research vessel. In designing this source, it was assumed that, as in previous studies, the exposure level would be directly measured using a calibrated animal-borne tag. This assumption relaxed the requirement for an omnidirectional source and made possible the use of a lightweight array with a more complex beam pattern.

A vertical line array (VLA) of active transducers was selected as the source configuration for projecting midfrequency, short-duration sounds. This VLA consisted of 15 individual transducer elements with a 15.2-cm (6-inch) center-to-center spacing, each driven by individual 800-W class D power amplifiers through step-up transformers and tuning inductors. The transducers (Geospectrum Technologies, Ltd., model #M21-3750) were of an air-backed, flexural disk design. Each transducer had two lead zirconate titanate (PZT) disks

bonded to metal disks, which were in turn bonded to a housing to form a closed air cavity. The transducers were each encapsulated in urethane to provide waterproofing and some mechanical damping. Their electroacoustic efficiency was approximately 86% at 3.8 kHz, which is the center frequency of both signals used in the SOCAL-BRS. The array structure was designed to be relatively lightweight and flexible to allow for hand deployment. Each transducer sat in a PVC “holder” through which four flexible wire ropes passed. The wire ropes supported the transducers and set the element spacing. The transducer holders were held in place with crimped-on locking collars.

The VLA was suspended from an aluminum pressure housing (Prevco, Inc.) on four stainless steel cables and powered through a 125-m Kevlar reinforced (1000-V-rated) electro-mechanical cable (Figure 1). Individual transducers were connected to tuning inductors mounted inside the pressure housing. The 38-mH inductors were wired in series with each transducer to minimize the volt-amps required from the amplifiers and also increase

the bandwidth of the system. Dry weight of the entire VLA was ~40 kg, including a small ballast weight attached to ensure the array hung vertically. A roll/pitch/depth sensor with RS-232 output was mounted inside the pressure vessel to measure the orientation of the source array in the water column. A vertical displacement angle of less than 5° was typically maintained during field operations, which typically occurred in sea states of Beaufort 3 or less (4 max). The total overall deployed dry weight of array, ballast, and cable was <50 kg (wet weight < 10 kg), enabling easy, safe, and rapid hand deployment by two or three people.

The dry-end of the system consisted of three amplifier banks, each containing five independent modules. The 800 W, Class D audio amplifiers were built by Harrison Labs and have a rated efficiency of 88% at full power. The amplifiers were powered by 12 V sealed lead acid batteries (one per amplifier). A custom Edcor USA step-up transformer increased the voltage out of the amplifier by a factor of 5.7 times. The batteries were recharged between each signal transmission

using simple sealed lead acid (SLA) chargers powered by 120 VAC, 10 A ship power. All components were shock-mounted in a rugged, shipping-ready rack (45 × 74 cm) readily loaded and housed on small research vessels. A 1U (1 unit standard-size) rack-mount source control computer with a National Instruments multichannel digital-to-analog (D/A) PCI (NI PCI-6723) card generated the audio signals driving the audio amplifiers.

The sound source system was controlled by a single operator using a laptop computer. A custom LABView™ program was used to set up and control the audio outputs. Time-delayed inputs to each transducer could be used to effectively steer the output beam to a desired elevation angle as required. A calibrated reference hydrophone was used to validate source performance and provide a degree of passive acoustic monitoring when the ship was stationary. Both the output signal and the signal received from the hydrophone were recorded, along with an Inter-range instrumentation group (IRIG) time signal derived from a GPS satellite, to allow precise signal reconstruction following CEEs.

The individual amplifier gains were set to maximum output rather than a uniform channel-to-channel output. This choice was made because it provided the maximum acoustic power rather than a finely shaped directional acoustic beam response. Each amplifier was driven with the same amplitude signal (no shading), but the option for shading was available in the software. Given the nature of the experiment and unpredictable nature of animals moving in a three-dimensional environment, an omnidirectional source would have been preferred. However, the acoustic power for an omnidirectional source with a 210-dB source

FIGURE 1

Schematic of system elements of SOCAL-BRS VLA sound source.

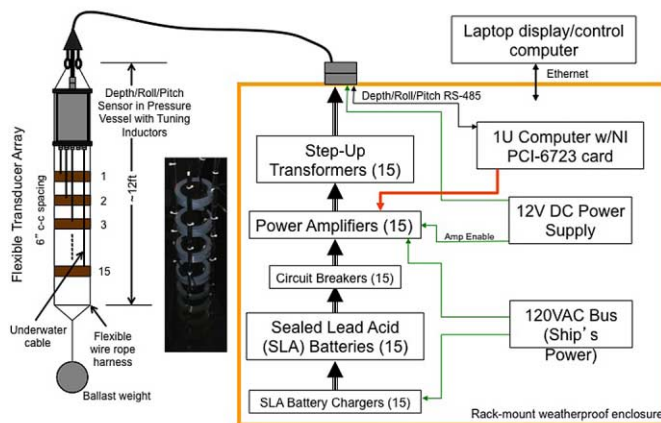

level is 8 kW, resulting in electrical power demands of >15 kW. Large, single-transducer solutions are possible, but the transducer costs are quite high (>\$100,000 k) and require custom high-power amplifiers, each of which are inconsistent with the design and objectives of the project.

Following a series of successful bench tests of the source elements and power configurations, the sound source array was tested and calibrated at both the Dodge Pond and Seneca Lake Test Facilities operated by the Naval Undersea Warfare Center. The sound source was also deployed, tested, and calibrated in the field ahead of its use in CEEs during SOCAL-10 (the first year of the SOCAL-BRS project in 2010). The results of these calibrations and the performance of the source in SOCAL-10 CEEs (and minor modifications for continued successful use in SOCAL-11) are described in greater detail below, but each was successful and within specifications. The engineering objectives of repeatedly producing loud, short-duration, midfrequency signals from a small source deployed and operated from a relatively small research vessel were met. This enabled the entire project to have a much leaner and more agile configuration relative to previous related efforts.

Overall Experimental Configuration

Like previous BRS efforts involving simulated sonar (see Tyack et al., 2011), the SOCAL-BRS involved a multidisciplinary research team. This included visual monitoring and animal photo-identification capabilities on both the central research vessel and the small (~6 m) rigid-hull inflatable boats (RHIBs), animal tagging teams based on RHIBs, a geographical information system specialist, an acoustic

engineer, and a chief scientist on the central research platform. Highly experienced scientists and engineers in each of these areas used state-of-the-art tools and technologies to tag and track marine mammals and safely conduct CEEs.

Because of the greatly reduced logistical and space requirements for the sound source, the central research vessels used were much smaller than in previous studies. Two phases of SOCAL-10 were conducted, the first based on a 22-m recreational dive vessel (the *M/V Truth* operated by Truth Aquatics in Santa Barbara, CA) and the second from a relatively small (35 m) oceanographic research vessel (the *R/V Robert Gordon Sproul* operated by Scripps Institution of Oceanography in San Diego, CA). Because of its smaller size, greater versatility, and reduced cost of operation, the *Truth* was selected as the central hub of research operations and sound source vessel for both phases of SOCAL-11. While the central research platforms from which operations were conducted and experimental sounds were transmitted were much smaller than previous studies, the opposite approach was taken regarding small boat operations.

In previous studies, operations were primarily based off the main platform or a nearby satellite boat until animals were located and (in most cases) a single very small (<5 m) inflatable boat with ~25 HP engine approached animals for tagging. In contrast, SOCAL-BRS put a premium on the use of two larger and much faster RHIBs capable of covering large areas independent of the central vessel. The resulting configuration, while similar in overall nature to previous studies, was more spatially dispersed and able to cover larger areas. Additionally,

operational teams on the RHIBs were always on the water, ready to respond immediately given tagging opportunities. The research vessel carrying the sound source remained close enough to the RHIBs that it could transit to either, once animals were tagged and conditions were suitable for CEEs to be conducted.

CEE Methodology

The overall objective of SOCAL-BRS is to better understand basic behavior and responses of different marine mammals to sound exposure in order to inform operational and management decisions about active sonar use. Since sounds similar to those being tested had previously been found to harm some marine mammals, care was taken to ensure that animals were not injured during the conduct of the research (see Boyd et al., 2008). Consequently and in accordance with permitting authorization for this work (U.S. National Marine Fisheries Service permit #14534 issued to N. Cyr with B. Southall as chief scientist, Channel Islands National Marine Sanctuary permit #2010-004 issued to B. Southall, and a consistency determination from the California Coastal Commission), a number of conditions for initiating and conducting CEEs were put in place.

The SOCAL-BRS CEE protocols were derived from those used in the Bahamas BRS study (see Tyack et al., 2011). However, SOCAL-10 and -11 selected a greater variety of focal species. These included not only certain toothed cetaceans (e.g., Cuvier's beaked whale [*Ziphius cavirostris*] and Risso's dolphin [*Grampus griseus*]) but also several large baleen whale species (e.g., blue whales [*Balaenoptera musculus*]). Because the operational configuration included two capable RHIBs, multiple tagged animals were

often involved in experimental trials. Requisite modifications and adaptations of the CEE methods and protocols are described below.

The following conditions were met prior to beginning CEEs. Acoustic monitoring tags had to be attached for a sufficient duration to reduce attachment disturbance effects and obtain a reasonable amount of baseline behavioral data. For baleen whales, this was a minimum of 45 min, whereas for toothed species, a 2-h baseline period was selected. Field personnel also had to confirm that there were no neonate calves in either the focal group or any groups that would be incidentally exposed; neonate status was defined by the presence of fetal folds for most species, but by age of ~6 months for endangered species. The sound source could not be operated within 1 nm of any landmass or within 3 nm of land within the Channel Islands National Marine Sanctuary. Additionally, the sound source could not be operated within 10 nm from the site of any previous sound transmissions on the same day. Finally, operational conditions (e.g., weather) had to support both successful completion of CEE and interpretation of results, as well as postexposure monitoring before CEEs could begin.

Provided these conditions were met, researchers would initiate CEEs. The sound source vessel was positioned ~1,000 m from a focal tagged animal, accounting for group movement/distribution to the extent possible. The source was deployed from the stern of the vessel while in a stationary position, which significantly reduced engine noise. Only small position adjustments were required to maintain a vertical orientation of the sound source. In cases where multiple animals were tagged, the source was positioned as

described above in relation to one individual and the other was typically further away. The source was then deployed to a specified depth (~30 m), and a minimum of four trained marine mammal observers would conduct and maintain a 360° visual survey to ensure that no marine mammals were within a 200-m “safety” radius of the source vessel during transmissions.

Either simulated MFA sonar or pseudorandom noise (PRN) signals in the same 3-4 kHz band were then transmitted at a starting source level of 160 dB at 1 m, with one transmission onset every 25 s ramped up by 3 dB per transmission to maximum output levels for each signal. The use of sound ramp-up protocols and relatively low starting levels were required conditions of the environmental permitting for this research. The ramp-up rate was selected to cover the large range of source output levels (~50 dB total range) within a reasonable time period given the other methodological protocols, but it should be noted that this is an aspect of SOCAL-BRS exposures that is different than exposure to a real military source; such a quick ramp-up could be interpreted as a rapid approach of a moving source. The MFA signal was 1.6 s in total duration, consisting of a 3.5- to 3.6-kHz linear FM sweep (0.5 s), then a 3.75-kHz tone (0.5 s), a 0.1-s delay, and finally a 4.05-kHz tone (0.5 s); it was projected at a maximum source level of 210 dB at 1 m. The duty cycle and waveform of the MFA signal were designed to be similar to some of those used by the U.S. Navy in their SQS-53C tactical midfrequency sonar systems; these systems use a variety of signals and operational configurations, but these parameters for the simulated sonar signals were within these conditions according to information provided

by the Navy. The PRN signal was designed with generally similar features to the MFA signal, but lacking the tonal characteristics and frequency modulation patterns. The PRN signal was 1.4 s in total duration, consisting of 3.5- to 4.05-Hz band-limited noise (1.0 s), a 0.1-s delay, and finally 3.5- to 4.05-Hz band-limited noise (0.3 s); it was projected at a maximum source level of 206 dB at 1 m. Transmitting this broader band signal at identical output characteristics to the MFA signal was not possible due to power limits of the source. The source was, however, extremely flexible in terms of capabilities to project a wide variety of sound stimuli within its functional bandwidth, enabling an adaptive approach if alternate waveforms were selected for use.

Transmissions of either signal type (each CEE consisted of only one) continued once every 25 s at the respective maximum source level for a total transmission time of 30 min, unless any contra-indicators required an early shutdown. These included any marine mammal observed within 200 m of the sound source and any abnormal behaviors indicating a potential for injury or clear separation of mothers and dependent offspring.

Following CEEs, post-exposure monitoring was conducted from both the source vessel and the RHIBs. It included visual scan surveys and (in most cases) passive acoustic monitoring of the immediate playback area using for at least 30 min, as well as monitoring of focal groups for at least 1 h post-CEE.

Results and Conclusions

Sound Source Development and Testing

The SOCAL-10 source was successfully tested and calibrated at the

NUWC Seneca Lake Test Facility on 11–12 August 2010. Full vertical beam patterns and source level measurements were taken. Peak resonance was measured at 3.8 kHz at a maximum source level of 210.5 dB with a -3 dB beam-width of ~8° (Figure 2).

Beam patterns were measured at depression angles of 0°, 10°, 15°, and 30°. The higher the steering angle, the higher the side lobes, which resulted in higher energy over a broader range of depths during CEEs. At a 15° steering angle, an average level of approximately 202 dB was maintained from 0° to 60° with an on-axis level of 210 dB (Figure 3).

Note that the individual transducer output levels were maximized rather than matched to each other. This generally results in the highest output power and relatively more prominent side lobes compared with a well-matched line array sound source. In this application, higher side lobes were not detrimental because a relatively omnidirectional beam pattern was desirable. Since the methodological protocols included measuring received exposure levels on animal-borne tags, it was much less critical that the animal be directly in the

FIGURE 3

Vertical beam pattern curves for the 15 element array with 15° beam steering (top) and with the array steered to 0° elevation angle (bottom), which was the nominal configuration in the field. With the array vertically deployed, 90° is oriented up; 0° and 180° are oriented horizontally.

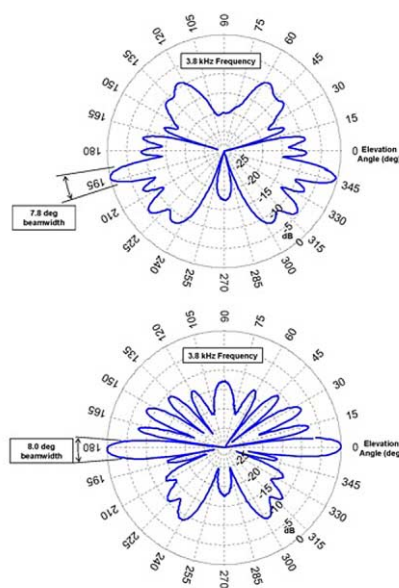

main lobe with a higher and known source level with which to estimate exposure. Rather, a relatively broader beam pattern was selected, yielding a more diffuse sound field in which the exposure goal of 100-160 dB RMS received sound level could be met over a

FIGURE 2

Source level from 2 to 7 kHz calibrated for a maximum output of 210 dB re: 1μPa (RMS).

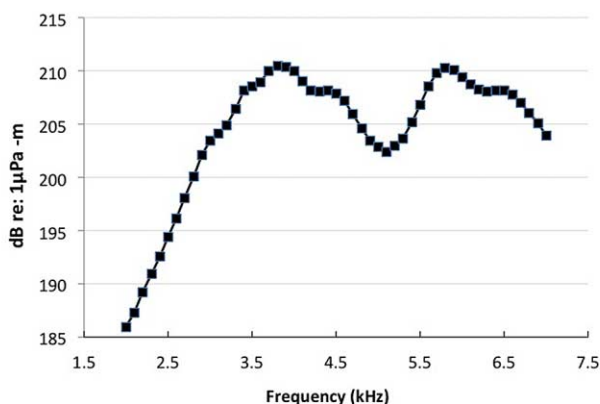

broader area. Exposures of multiple species were generally near-surface (<200 m), with the exception of the two Cuvier’s beaked whales.

Following the Seneca Lake calibrations, the sound source was successfully tested in the field and used during CEEs in SOCAL-10 and -11. Spectrograms and relative transmit voltages for each signal type, as transmitted from the control computer to the source, are given in Figure 4. Deployment was successfully and safely conducted both by hand from the smaller dive vessel (*R/V Truth*) and via a conventional A-frame aboard the larger research vessel (*R/V Robert Gordon Sproul*). Deployment and recovery time was approximately twice as fast (~4 min) when conducted by hand on the *M/V Truth*. Based on measurements made within 10 m of the sound source with a calibrated hydrophone and simple spreading loss calculations, transmissions in the field were consistent with the Seneca Lake calibration in terms of calculated source levels.

While stimulus waveforms and source output levels were precisely reproduced as expected, some problems were encountered in the temporal spacing of transmission sequences due to D/A hardware errors. Transmitted waveforms recorded from a monitoring channel showing signals sent from a control computer to the source for a typical sound transmission sequence in SOCAL-10 (Figure 5) show the resulting irregularities in the planned 25 s signal onset duty cycle typical of some sequences in SOCAL-10.

As evident in this figure, these irregularities did not affect the relative transmit levels in the ramp-up or full power signals or the total duration of transmissions. The D/A card was subsequently replaced following

FIGURE 4

Spectrograms of individual MFA (A) and PRN (B) signals (amplitude is in relative voltage) sent from the control computer to the sound source. Individual signal elements were projected at different output voltages corresponding to different target source levels within a transmit sequence.

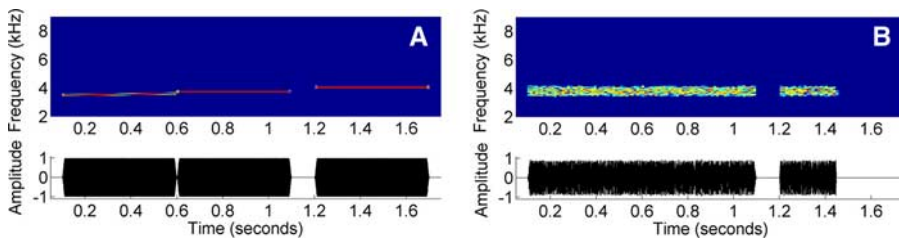

SOCAL-10, and the timing irregularities were eliminated for SOCAL-11.

Calibrated measurements of both signal types were made during SOCAL BRS CEEs using the source monitoring hydrophone and the acoustic tags. Figure 6 shows a single transmission of an MFA signal recorded during Seneca Lake calibrations, along with an MFA signal recorded on a blue whale during a CEE. The transmitted source level of 210 dB at 1 m, which was extremely consistent across many transmissions during calibration testing, resulted in a received level (maximum RMS level in any 200 ms analysis window over the 1/3 octave band centered at 3.7 kHz; details of the RL analysis methods were as

reported in Tyack et al., 2011) of 156 dB on the animal. Precise distances to focal animals for any transmission were difficult to determine, especially when the animal was submerged and not visible, since the tags used did not transmit any positional information. However, the estimate of horizontal range from this animal to the sound source for the sighting closest to the time of this transmission was approximately 1400 m. As is evident, signal characteristics were well preserved in the received signal on the animal, with the expected reverberation patterns evident, and the maximum output level resulting in a received level near the top of the target range.

FIGURE 5

Waveform display from a monitoring channel showing signals (in relative voltage) sent from control computer to sound source during a CEE; the transmit sequence (typical for both signal types) shows the ramp-up to full power and ~30 min transmission interval.

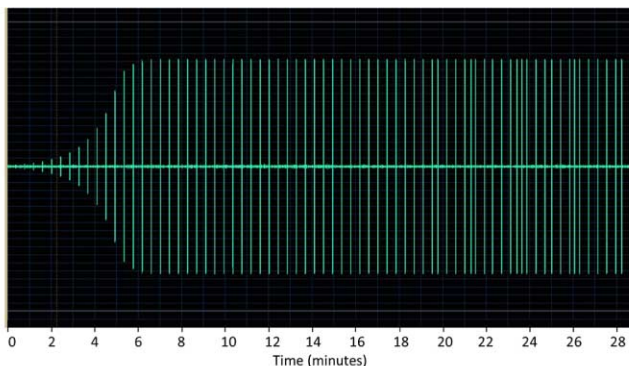

Similar results were obtained with the PRN signal. A single PRN transmission recorded during Seneca Lake calibrations is plotted with a signal recorded on another blue whale during a different CEE in Figure 7. The transmitted source level of 206 dB at 1 m resulted in a maximum received level of 152 dB on the animal (measured as described earlier for the MFA signal). Again, precise distance to the animal for any transmission is difficult to determine, but the estimated horizontal range from the animal to the sound source for the sighting closest to the time of this transmission was approximately 1,600 m. As for the MFA signal, the PRN characteristics are well preserved in the received sound waveform on the animal, some reverberation is present, and the received levels are near the upper end of the target range using the maximum sound output level.

The above examples demonstrate the efficacy of the source performance, experimental methodology, and operational configuration to result in signals received by individual free-ranging marine mammals within specified parameters and exposure levels. The sound source was notionally positioned approximately 1,000 m from focal animals during CEEs, but animals frequently moved just prior to or during transmissions or, in some cases, two animals were tagged and the source vessel maneuvered to the target range from one of the two. Tagged individuals were consequently between about 500 and 4,000 m during CEE transmissions. Given the 50-dB dynamic range of source output levels, the inherent variability in sound propagation in different conditions across CEEs, relative animal and tag position during CEEs, and other factors, received exposure levels differed

FIGURE 6

Spectrogram displays of a single MFA signal transmission. (A) Recorded with a calibrated reference hydrophone at 22.3-m range (levels referenced to 1-m range) using 210 dB RMS source-level output setting. (B) Recorded from a calibrated DTAG attached to a blue whale on 3 September 2010 during a SOCAL-BRS CEE sequence (max RMS level in any 200 ms analysis window was 156 dB; see text for additional details). [Note both figures have a 50-dB color scale range but ranges differ between plots].

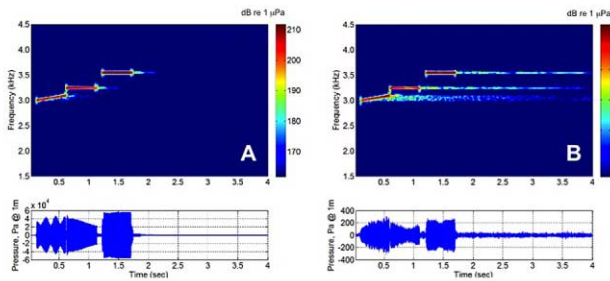
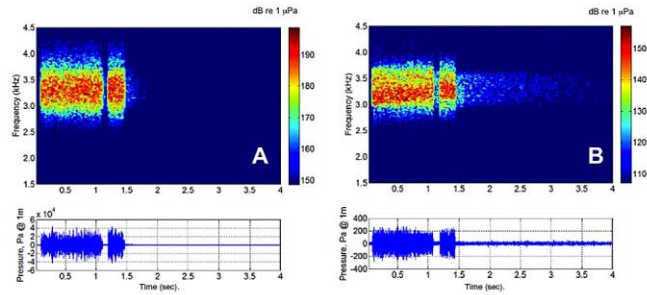

FIGURE 7

Spectrogram displays of a single PRN signal transmission. (A) Recorded with a calibrated reference hydrophone at 22.3 m range (levels referenced to 1-m range) using 206 dB RMS source level output setting. (B) Recorded from a calibrated DTAG attached to a blue whale on 23 Sept 2010 during a SOCAL-BRS CEE sequence (max RMS level in any 200 ms analysis window was 152 dB; see text for additional details). [Note both figures have a 50 dB color scale range but ranges differ between plots].



across subjects and species. However, despite all these sources of variability, received levels for the multiple individuals and species tested clearly fall within the specified target range (100-160 dB) of received levels (Figure 8). These results are presented in order to show the general patterns of exposure relative to specified target levels rather than individual exposure patterns or changes in behavior as a function of exposure.

Received levels for MFA signals are generally slightly higher than PRN, likely the result of the 4 dB difference in maximum source levels between the two stimuli. Additionally, received levels were distributed across the range of target levels. Obtaining these variable exposure levels within individuals of a focal species (three of the five tested are shown above) is an element of the experimental design, as it enables assessments of behavioral response as a function of exposure level. Received levels across the full target range were achieved in the 26 blue whale CEEs. For the odontocetes cetaceans tested, somewhat lower maximum received level conditions were experienced,

although it should be noted that the sample sizes are considerably less (six Risso's dolphins and two Cuvier's beaked whales). Additionally, most of these exposures were measured with a newer version DTAG using acoustic calibration data obtained from a small number of the new tags; more comprehensive calibration of the new tags could necessitate small corrections

to the reported levels, although these are not likely to change the general pattern of lower maximum exposure levels in the odontocete versus mysticete cetaceans.

In summary, the custom-designed VLA sound source developed for SOCAL-BRS was successfully tested, calibrated, and used in the context of CEEs. It met or exceeded almost all

FIGURE 8

Histograms showing relative proportions (within species) of received levels (in 5 dB bins) of MFA and PRN signals measured with calibrated DTAGs during SOCAL-BRS CEE sequences from 2010 and 2011 for 26 blue whales (top), 6 Risso's dolphins (middle), and 2 Cuvier's beaked whales (bottom; MFA only).

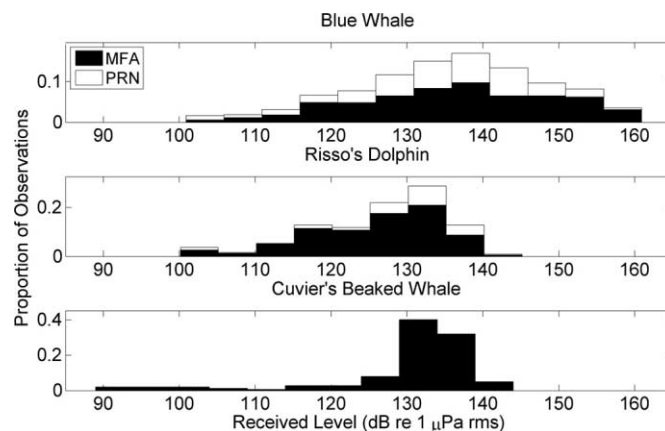

design specifications and was easily hand-deployed from a small research vessel. This proved to be a critical enabling factor in the overall effort to reduce the overall size, complexity, and flexibility of the experimental methodology. Future efforts are underway to reduce source size even further, particularly on the dry end of the system, to enable deployment from even smaller (~10 m) boats while maintaining the same output characteristics.

Summary of Accomplishments and Assessment of Overall Experimental Configuration

Within the first two seasons of SOCAL-BRS, efforts to reduce the overall size, cost, logistical complexity, and rigid schedules of earlier studies while maintaining a comparable experimental paradigm and maximizing scientific results were quite successful. The research team had a similar interdisciplinary configuration as previous projects but involved approximately half as many people and approximately one-third the total cost. During the course of the first 2 years of the experiment (SOCAL-10 and -11), a total of 101 tags of six different types were attached to 79 individuals of at least eight different marine mammal species (see Southall et al., 2011, 2012, for additional details). Tags were successfully attached to at least one marine mammal (and in many cases multiple animals) on 77% of all SOCAL-BRS operational field days (39/51 days) of the first two field seasons.

Additionally, a total of 46 CEEs were successfully completed (on 61% of all SOCAL-BRS operational field days, 31/51 days) involving individuals of five marine mammal species, which was a level of productivity and

species diversity well beyond expectations based on the results of previous efforts. Additionally, SOCAL-BRS conducted the first ever CEEs on Cuvier's beaked whale, which is the predominant species represented in previous stranding events involving military sonar. Furthermore, the SOCAL-BRS experimental configuration enabled multiple tags to be deployed on individuals of some species (notably blue whales) with prolonged focal follow data from multiple RHIBs on different animals at different ranges from the sound source during CEEs. Received sound levels for all species tested achieved the target range specified prior to CEEs. Exposures for mysticete cetaceans were distributed across the 100–160 dB range while odontocete received levels were more typically from 100 to 140 dB. This is likely because some of the odontocete CEEs involved subjects at greater horizontal range from the sound source and also because some individuals (most notably the beaked whales) were at much greater depths during exposure. Vertically down-steering the source directivity pattern should be considered as a means of potentially increasing received levels for deeper-diving species when their vertical position in the water column is reasonably well known during CEEs. Detailed analyses of exposure conditions and behavioral responses are not presented here but are ongoing, and some initial results are available (DeRuiter et al., 2011; Goldbogen et al., 2011; Southall et al., 2011, 2012).

Key developments in SOCAL-BRS included the use of a smaller primary research vessel enabled by a smaller, more easily handled sound source and the decentralized approach with larger, faster, and more wide-ranging RHIBs working on the water at all

times. These changes in configuration and the general mode of operation, which allowed selection of focal species and areas based on the weather and animal availability, clearly resulted in the intended increase in the number of animals tagged and total CEEs successfully completed. However, in comparing the SOCAL-BRS results with other previous and ongoing behavioral responses studies involving active sonar, there are a number of important considerations.

For instance, 46 CEEs were completed in SOCAL-BRS compared to five in the Bahamas BRS (each with a comparable number of field days in two seasons), but an equal number of beaked whale CEEs were conducted in each study (two total) albeit on different beaked whale species. The Bahamas effort was almost entirely focused on beaked whales, while SOCAL-BRS focused on beaked whales during the relatively rare times weather conditions were suitable and maintained options to work on other important species nearby at other times. The increased success rate of the first phase of the 3S field seasons (14 CEEs in three field seasons) also appears to be a function of having multiple options for focal species, including some easier to tag species, and operational areas. It should also be noted that the 3S configuration does enable the use of an actual operational sonar system used in military training operations and capable of being towed; the SOCAL-BRS configuration resulted in less realistic simulated exposures because of the inability to tow the sound source.

Clearly there are area- and species-related characteristics that favor different methodological and operational configurations to best address these challenging field research questions.

The approach selected for SOCAL-BRS appears to have worked well for the objectives identified and the field conditions encountered, but it is by no means the ideal approach for all circumstances. Subsequent efforts will likely be increasingly adaptive and smaller in the overall configuration of research teams. Furthermore, evolution toward exposure conditions that are more similar to real-world exposures to human sound are increasingly important to add to the growing knowledge of response to scaled-down sources. These two progressions are not necessarily in conflict with one another but will require increasing collaboration between the research and military communities to address applied questions about the real risks of impact from operations to marine mammals. Advances in acoustic and other technologies will continue to enable these and other refinements of experimental methodologies to address key biological and management research questions.

Acknowledgments

The authors would like to especially acknowledge the tireless and exceptional efforts of the entire SOCAL-BRS field and analytical teams. Over 40 individuals have been directly involved in planning, completing, and assessing the results of SOCAL-BRS, and this project would not have been possible without them. We would also like to thank the project sponsors, the U.S. Navy Chief of Naval Operations, Environmental Readiness Program under Drs. Frank Stone and Bob Gisiner and the Office of Naval Research Marine Mammal Program under Dr. Mike Weise. We also appreciate the support and collaboration of the U.S. Navy's SCORE range based

on San Clemente Island. Discussions regarding experimental design and protective measures with the U.S. Marine Mammal Commission and the California Coastal Commissions were particularly helpful as well. Finally, various staff in NOAA's National Marine Fisheries Service (Office of Protected Resources, Southwest Fisheries Science Center), Southwest Regional Stranding Network, and Channel Islands Marine Sanctuary were also extremely instrumental throughout the project.

Corresponding Author:

Brandon Southall
Southall Environmental
Associates, Inc.
9099 Soquel Dr., St. 8,
Aptos CA, 95003
Email: Brandon.Southall@sea-inc.net;
www.socal-brs.org

References

- Balcomb**, K.C.I., & Claridge, D.E. 2001. A mass stranding of cetaceans caused by naval sonar in the Bahamas. *Bahamas J Sci.* 2:2-12.
- Boyd**, I.L., Brownell, R., Cato, D., Clark, C., Costa, D., Evans, P., ... Zimmer, W. 2008. The effects of anthropogenic sound on marine mammals: A draft research strategy. Oxford, UK: European Science Foundation, Marine Board.
- Clark**, C.W., Ellison, W.T., Southall, B.L., Hatch, L., Van Parijs, S.M., Frankel, A., & Ponirakis, D. 2009. Acoustic masking in marine ecosystems: intuitions, analysis, and implication. *Mar Ecol Prog Ser.* 395:201-22. <http://dx.doi.org/10.3354/meps08402>.
- Cox**, T.M., Ragen, T.J., Read, A.J., Vos, E., Baird, R.W., Balcomb, K., ... Benner, L. 2006. Understanding the impacts of anthropogenic sound on beaked whales. *JCRM* 7:177-87.
- D'Amico**, A., Gisiner, R.C., Ketten, D.R., Hammock, J.A., Johnson, C., Tyack, P.L., & Mead, J. 2009. Beaked whale strandings and naval exercises. *Aquat Mamm.* 35:452-72. <http://dx.doi.org/10.1578/AM.35.4.2009.452>.
- D'Amico**, A., Southall, B., & Tyack, P. 2010. MED-09 Final Cruise Report. SSC Pacific-Technical Document #3243.
- DeRuiter**, S.L., Calambokidis, J., Douglass, A., Falcone, E., Frieblaender, A., Goldbogen, J., ... Tyack, P. 2011. Effects of simulated military sonar on sound production by blue whales, fin whales, sperm whales, Risso's dolphin, and Cuvier's beaked whale. In: The 4th International Science Symposium on Biologging. Hobart, Tasmania, 14-18 March.
- Fernandez**, A., Edwards, J.F., Rodriguea, F., Espinosa de los Monteros, A., Herraiz, P., Castro, P., ... Arbelo, M. 2005. Gas and fat embolic syndrome involving a mass stranding of beaked 1242 whales (family Ziphiidae) exposed to anthropogenic sonar signals. *Vet Pathol.* 42:446-57. <http://dx.doi.org/10.1354/vp.42-4-446>.
- Frantzis**, A. 1998. Does acoustic testing strand whales? *Nature* 392:29. <http://dx.doi.org/10.1038/32068>.
- Goldbogen**, J.A., Calambokidis, J., DeRuiter, S.L., Douglas, A.B., Falcone, E., Friedlaender, A.S., ... Tyack, P.L. 2011. Dynamics of blue and fin whale maneuverability: three-dimensional kinematic analyses for assessing the effects of sound on behavior. In: The 4th International Science Symposium on Biologging. Hobart, Tasmania, 14-18 March.
- Johnson**, M., Aguilar de Soto, N., & Madsen, P.T. 2009. Studying the behaviour and sensory ecology of marine mammals using acoustic recording tags: a review. *Mar Ecol Prog Ser.* 395:55-73. <http://dx.doi.org/10.3354/meps08255>.
- Marques**, T.A., Thomas, L., Ward, J., DiMarzio, N., & Tyack, P.L. 2009. Estimating cetacean population density using fixed passive acoustic sensors: An example with Blaineville's beaked whales. *J Acoust Soc Am.* 125:1982-94. <http://dx.doi.org/10.1121/1.3089590>.
- McCarthy**, E., Moretti, D., Thomas, L., DiMarzio, N., Morrissey, R., Jarvis, S., ...

- Dilley, A. 2011. Changes in spatial and temporal distribution and vocal behavior of Blainville's beaked whales (*Mesoplodon densirostris*) during multiship exercises with mid-frequency sonar. *Mar Mamm Sci.* 27(3):E206-26.
- Moretti, D., DiMarzio, N., Morrissey, R., Ward, J., & Jarvis, S.** 2006. Estimating the density of Blainville's beaked whale (*Mesoplodon densirostris*) in the Tongue of the Ocean (TOTO) using passive acoustics. In: Proceedings of the MTS/IEEE Oceans 2006 Conference and Exhibition (pp. 5).
- National Research Council (NRC).** 2003. Ocean Noise and Marine Mammals. Washington, DC: National Academy Press.
- National Research Council (NRC).** 2005. Marine Mammal Populations and Ocean Noise: Determining when Noise Causes Biologically Significant Events. Washington, DC: National Academy Press.
- Southall, B., Berkson, J., Bowen, D., Brake, R., Eckman, J., Field, J., ... Winokur, R.** 2009. Addressing the Effects of Human-Generated Sound on Marine Life: An Integrated Research Plan for US Federal Agencies. Washington, DC: Interagency Task Force on Anthropogenic Sound and the Marine Environment of the Joint Subcommittee on Ocean Science and Technology.
- Southall, B.L., Bowles, A.E., Ellison, W.T., Finneran, J.J., Gentry, R.L., Greene, C.R., Jr., ... Tyack, P.L.** 2007. Marine mammal noise exposure criteria: Initial scientific recommendations. *Aquat Mamm.* 33:411-522. <http://dx.doi.org/10.1578/AM.33.4.2007.411>.
- Southall, B.L., Calambokidis, J., Tyack, P., Moretti, D., Hildebrand, J., Kyburg, C., ... Barlow, J.** 2011. Project report: Biological and Behavioral Response Studies of Marine Mammals in Southern California, 2010 (SOCAL-10).
- Southall, B.L., Calambokidis, J., Tyack, P., Moretti, D., Friedlaender, A., DeRuiter, S., ... Barlow, A.J.** 2012. Project report: Biological and Behavioral Response Studies of Marine Mammals in Southern California, 2011 (SOCAL-11). [Available at: http://sea-inc.net/wp-content/uploads/2012/03/SOCAL-11_FINAL-Project-Report.pdf].
- Tyack, P.** 2009. Acoustic playback experiments to study behavioral responses of free-ranging marine animals to anthropogenic sound. *Mar Ecol Prog Ser.* 395:187-200. <http://dx.doi.org/10.3354/meps08363>.
- Tyack, P.L., Zimmer, W.M.X., Moretti, D., Southall, B.L., Claridge, D.E., Durban, J.W., ... Boyd, I.L.** 2011. Beaked whales respond to simulated and actual navy sonar. *PLoS ONE* 6(3):e17009. doi: 10.1371/journal.pone.0017009.
- Van Parijs, S.M., Clark, C.W., Sousa-Lima, R.S., Parks, S.E., Rankin, S., Risch, D., & Van Opzeeland, I.C.** 2009. Management and research applications of real-time and archival passive acoustic sensors over varying temporal and spatial scales. *Mar Ecol Prog Ser.* 395:21-36. <http://dx.doi.org/10.3354/meps08123>.